



ET3288-SC

Instruction Manual



WARNING

To reduce the risk of injury, read and understand these safety warnings and instructions before using the products. Keep these instructions with the tool for future reference. If you have any questions, contact your **MAC TOOLS** representative or distributor.

© 2018 Mac Tools

WI-FI VIDEO SCOPE

TABLE OF CONTENTS

Product Description	1
Applications	1
Technical Data	1
Component Overview	2
Wi-Fi Video Scope Hardware Set-up	2
Android™ Phone and Tablet Software Setup	3
iPhone® and iPad® Software Setup	4
Using the Mac Tools Wi-Fi Video Scope - Mobile Devices	5
Camera Selection Page	5
Camera Preview Page	6
Viewing and Sharing Saved Images and Videos	7-8
Application Settings	9
Customer Service	10

PRODUCT DESCRIPTION

The Mac Tools Wi-Fi Video Scope is a portable, hand-held, multi functional inspection camera featuring an ultra-compact 5.5mm diameter camera and a high quality digital sensor that provides crystal clear video output. The camera connects via Wi-Fi to most smart devices and PCs for convenient viewing on any size screen. Using the free downloadable app; video, still images, and sound can be recorded, saved, and shared. Up to five viewing devices may be connected to the Wi-Fi at one time.

APPLICATIONS

The Mac Tools Wi-Fi Video Scope has many potential applications, including, but not limited to:

- Automotive repair and maintenance
- Inspection of hard-to-see areas on vehicles, equipment, and structures
- Plumbing and construction
- Heating and air conditioning repair

NOTE: This product is not intended for medical use.

TECHNICAL DATA

DESCRIPTION	DATA
Network Standard	IEEE 802.11 b/g/n
Antenna	Built in IPEX antenna
Operating Frequency	2.4 GHz
Date Rate	802.11 a/b/g/n up to 150 Mbps
Camera Diameter	7/32" (5.5mm)
Shaft Length	3-1/4' (1m)
Video Resolution	640x480
Viewing Angle	60°
Depth of Field	2-1/3" - 4" (60mm-100mm)
Camera Light Source	Six adjustable high intensity LEDs
Water/Dirt Resistance	IP67 certified
LED Flashlight	1 CREE LED
Operating Temperature	32° to 113°F (0° to 45°C)
Power Source	4x AA batteries
Max Battery Life	2-3 hours continuous use

COMPONENT OVERVIEW

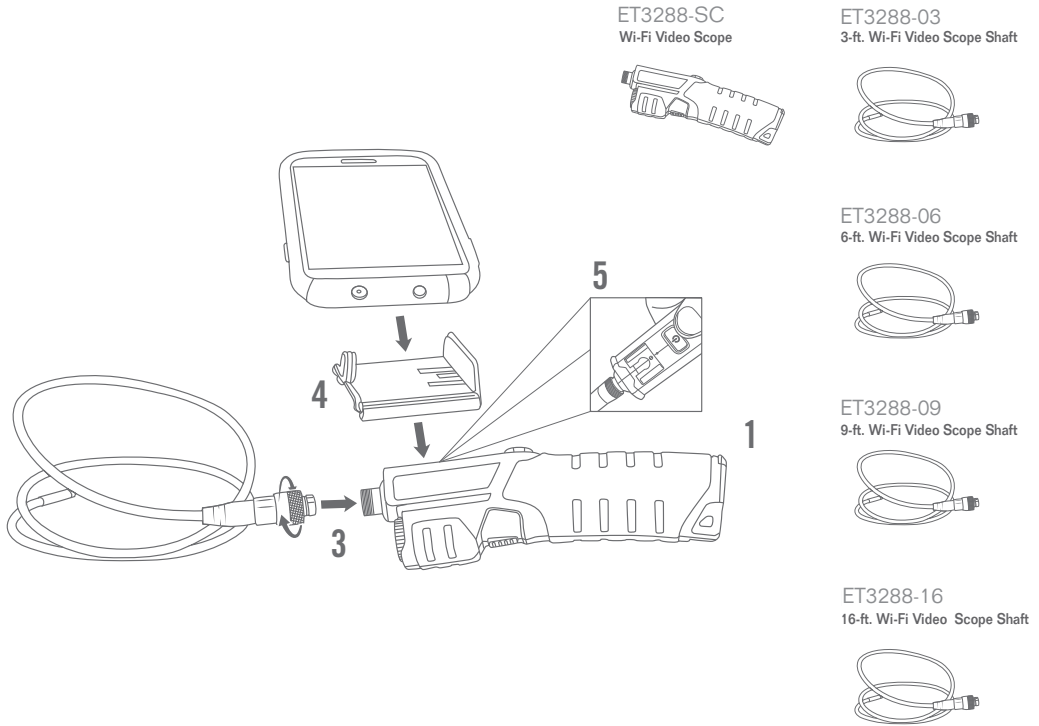

WI-FI VIDEO SCOPE HARDWARE SET-UP

1. Open battery compartment by sliding battery door down
2. Insert four AA alkaline batteries, making sure to insert correctly according to polarity
3. Attach camera shaft by twisting barrel connector clockwise
4. If you wish to use the device holder, slide the device holder into the bracket on top of the scope until it clicks and locks
5. Press the POWER button

ANDROID™ PHONE AND TABLET SOFTWARE SETUP

- Open Google Play™ store and search for “Mac Tools Video Scope”
- Download and install app
- On your Android™ device, open the device settings
- From the device settings, select “Wi-Fi Settings”
- Press the “Search” button to scan for Wi-Fi networks
- Select the “Wi-Fi_Video_Scope” network
- Connect to the network and enter the password “MACTOOLS”
- Start the Mac Tools Wi-Fi Video scope application

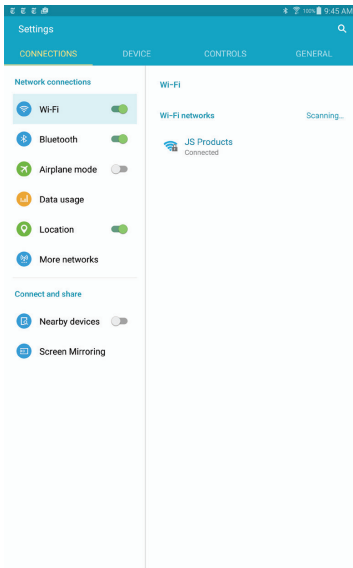

Wi-Fi Settings Screen

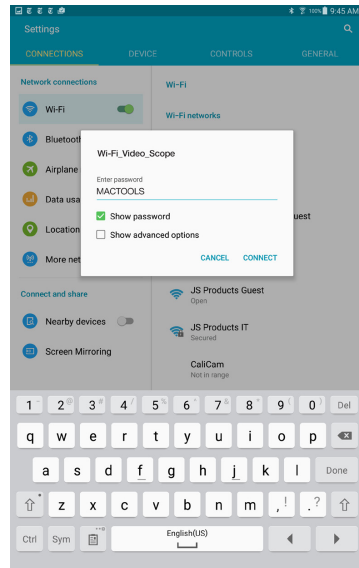

Wi-Fi Connection Screen

IPHONE® AND IPAD® SOFTWARE SETUP

- Open iTunes Store and search for “Mac Tools Video Scope”
- Download and install app
- On your iPhone® or iPad® open the device settings
- From the device settings, select “Wi-Fi Settings”
- Select the “Wi-Fi_Video_Scope” network
- Connect to the network and enter the password “MACTOOLS”
- Start the Mac Tools Wi-Fi Video scope application

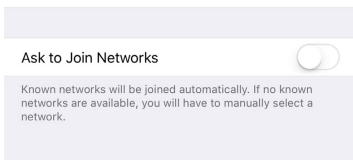
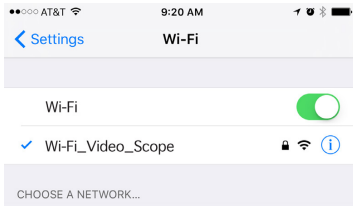

Wi-Fi Settings Screen

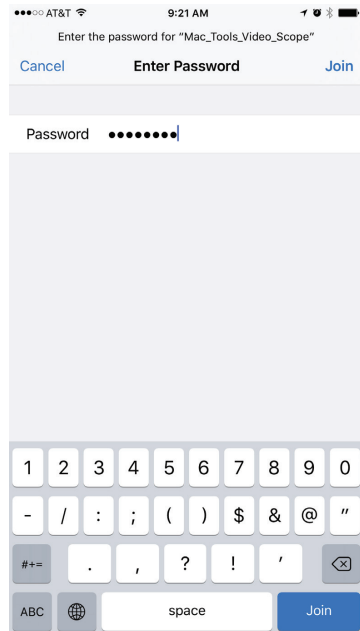

Wi-Fi Connection Screen

USING THE MAC TOOLS WI-FI VIDEO SCOPE ANDROID, IPHONE, AND IPAD

CAMERA SELECTION PAGE

- Launch the Mac Tools Wi-Fi Video Scope App
- From the “Camera” page, select “Mac Tools Video Scope”

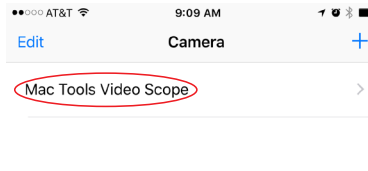



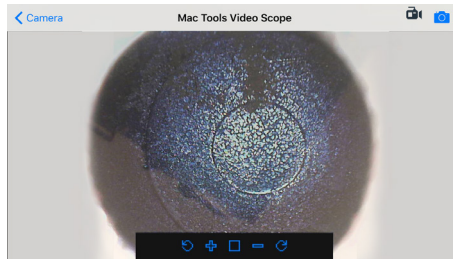

Camera Page

CAMERA PREVIEW PAGE





The camera preview page displays a real time picture of what the camera is aimed at and also allows control over camera functions.



Camera Preview Page

- To increase or decrease the size of the video scope image, press the  and  buttons
- Press the  to rotate the view counter clockwise or  to rotate the view clockwise
- To fit the video scope image to your screen automatically, press the  button

NOTE: The picture size and position can also be adjusted by using pinch and drag finger actions on the touch screen of smart devices

- To capture an image of what the camera is currently displaying, press the  button.
A message that the image was successfully saved will be displayed: 
- To record a video, press the  button. The  will flash GREEN and a REC will appear, along with a timer of the elapsed time of the recording: **REC 00:07**
- To return to the Camera Selection screen, press the  Back button

VIEWING AND SHARING SAVED IMAGES AND VIDEOS

Still images and videos that are taken during use of the Wi-Fi Video Scope are saved to a media gallery in the app. From the Media Gallery, these files can be viewed and shared with others.

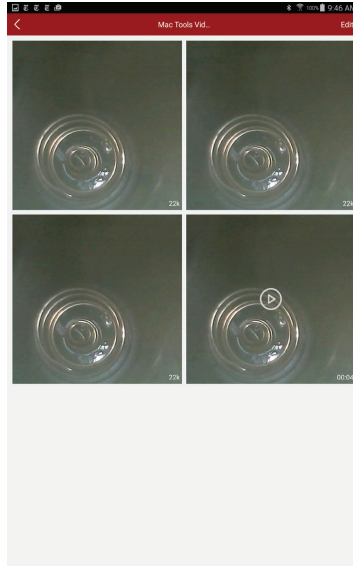

Media Gallery

- To access the Media Gallery, click the  button from the Camera Selection page
- Select the “Mac Tools Video Scope” from the Source List. Thumbnails of all saved items will be displayed
- Tap on any file to view it. Tap and hold on the file to delete or share

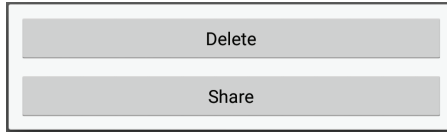

Delete/Share Screen

- Press the back button to return to the Media Gallery
- To delete multiple files, press the **Edit** button. Select the checkbox of each file you wish to delete and press the **Delete** button

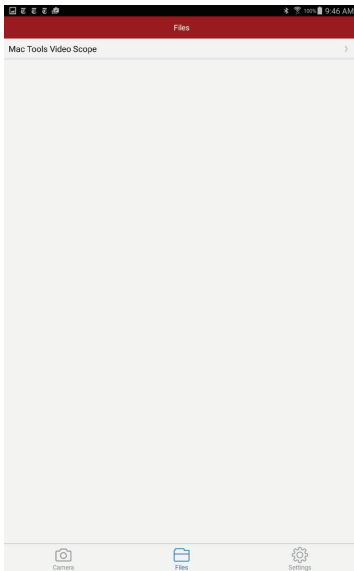

Source List

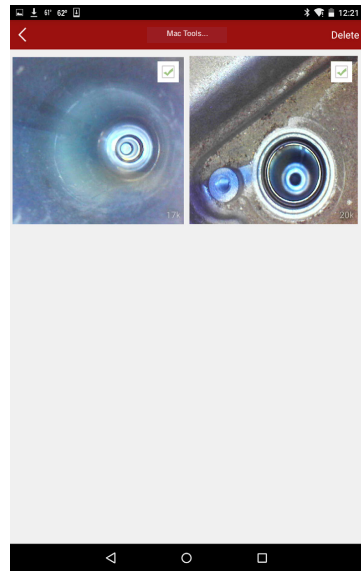

Edit Page

APPLICATION SETTINGS

Several software functions can be modified using the app settings. Additionally, customer support contact information can be found here.

- To access the app settings, click on the  button from the Camera Selection screen
- The Auto Record Audio Slider determines if the microphone will be activated or not during recording. To turn on the microphone, move the slider to the right position. To turn off, move the slider to the left position.

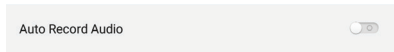

Auto Record Audio Slider

- The Record Length Selector determines the maximum amount of time per video that will be recorded. To increase or decrease the value, press the record button until the desired value is achieved.

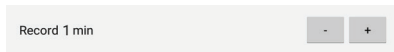

Record Length Selector

- The About Us button gives useful information about the product, including customer service contact information

CUSTOMER SERVICE

We at Mac Tools are committed to our customers, please reference the following phone number for a direct contact to one of our customer technicians. They will be more than happy to help with any service or warranty questions you may have about your product.

iPhone® and iPad® are registered trademarks of Apple Incorporated.

**Mac Tools
505 North Cleveland Avenue
Westerville, Ohio 43082
800.MACTOOLS
MACTOOLS.COM**

**Made in China
Hecho en China
Fabriqué En Chine**